

1.27mm Pitch Two-Piece Connector

HIF6 Series

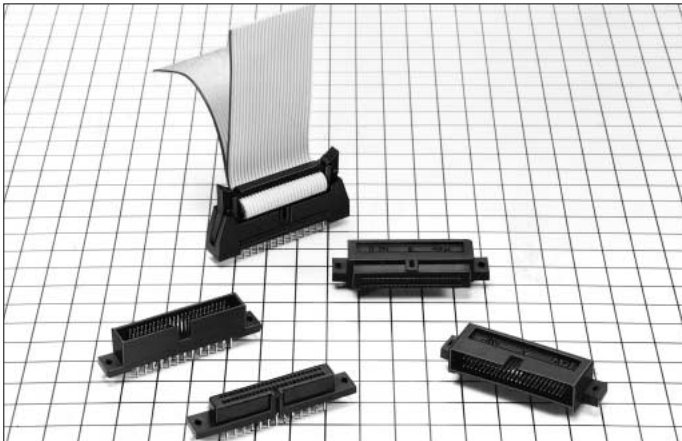

■Features

1. Product Variation

The connection method is available with the board to board type and insulation displacement type.

2. Broad applications

HIF2E, HIF3B and HIF5 can be combined one other, because the 1.27mm pitch flat cable is used.

3. Applicable Cables

The applicable cable is a (UL2651) AWG #28 flat cable (7cores: 0.127mm, outer jacket diameter: 0.8 to 1.0mm)

4. Mis-insertion Preventive Structure

The mis-insertion preventive guide prevents mis-insertion.

■Applications

Computers, peripheral and terminal equipment, PPC, various kinds of electronic equipment, Office Automation machines

■Product Specifications

Rating	Current rating: 0.5A Voltage rating: 125V AC	Operating Temperature Range: -55 to +85 °C (Note 1) Operating Humidity Range: 40 to 80%	Storage Temperature Range: -10 to +60°C (Note 2) Operating Humidity Range: 40 to 70% (Note 2)
--------	---	--	--

Item	Specification	Condition
1. Insulation Resistance	1000M ohms min.	250V DC
2. Withstanding Voltage	No flashover or insulation breakdown.	300V AC/1 minute.
3. Contact Resistance	30m ohms max.	0.1A
4. Vibration	No electrical discontinuity of 1 μ s or more	Frequency: 10 to 55 Hz, single amplitude of 0.75 mm, 2 hours in each of the 3 directions.
5. Humidity (Steady state)	Insulation resistance: 1000M ohms min.	96 hours at temperature of 40°C and humidity of 90% to 95%
6. Temperature Cycle	No damage, cracks, or parts looseness.	(-65°C: 30 minutes → 15 to 35°C: 5 minutes max. → 125°C: 30 minutes → 15 to 35°C: 5 minutes max.) 5 cycles
7. Operating Life	Contact resistance: 30m ohms max.	500 cycles
8. Resistance to Soldering heat	No deformation of components affecting performance.	Flow: 260°C for 10 seconds Manual soldering: 300°C for 3 seconds

Note 1: Includes temperature rise caused by current flow.

Note 2: The term "storage" refers to products stored for long period of time prior to mounting and use. Operating Temperature Range and Humidity range covers non conducting condition of installed connectors in storage, shipment or during transportation.

Connector in combination with the HIF6 series connection type

●HIF3B Series

(MIL-C-83503)

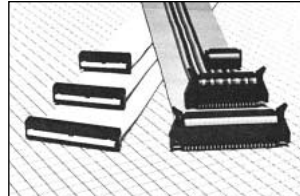

●HIF2 Series

(Board direct mount type)

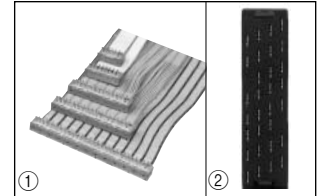

●HIF5 Series

(Card edge type)

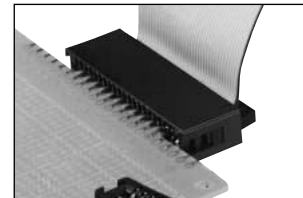

●RC Series

(Micro ribbon connector)

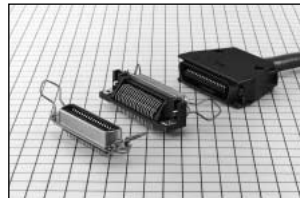

●FD Series

(D sub-ribbon connector)

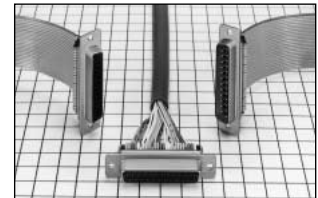

Photo① (For further information, refer to catalog page A133.)

Material

Parts	Material	Finish	Remarks
Insulator	PBT	Black	UL94V-0
Socket Contact	Copper alloy	Selective gold plating	_____
Pin header Contact	Brass		

Ordering Information

Socket and Receptacle

HIF6 A - * D A - 1.27 DSA L
 ① ② ③ ④ ⑤ ⑥ ⑦ ⑧

① Series Name	: HIF6
② No symbol	: Ribbon cable insulation displacement type
A	: With board mounting hole
B	: Without board mounting hole
③ Number of contacts	: 20, 26, 32, 34, 40, 50, 52, 60, 68, 80, 100
④ D	: Socket or receptacle
⑤ A	: Selective gold plating
⑥ Contact pitch	: 1.27mm
⑦ Contact type	: DS : Right angle type DSA : Straight type R : Ribbon cable ID type
⑧ L	: Board pre-fixed lock pin

Pin Header

HIF6 A - * P A - 1.27 DSA L
 ① ② ③ ④ ⑤ ⑥ ⑦ ⑧

① Series Name	: HIF6
② No symbol	: With lock
A	: With board mounting hole
B	: Without board mounting hole
③ Number of contacts	: 20, 26, 32, 34, 40, 50, 52, 60, 68, 80, 100
④ P	: Pin header
⑤ A	: Selective gold plating
⑥ Contact pitch	: 1.27mm
⑦ Contact style	: DS : Right angle type DSA : Straight type
⑧ L	: Board pre-fixed lock pin

◆Function Chart

Pin Header

Socket or Receptacle Side

Right Angle
Type with lock

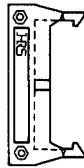

Straight Type
with lock

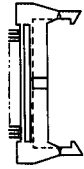

Right Angle
Type with
mounting hole

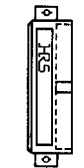

Straight Type
with mounting
hole

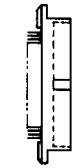

Right Angle
Type without
mounting hole

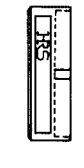

Straight Type
without
mounting hole

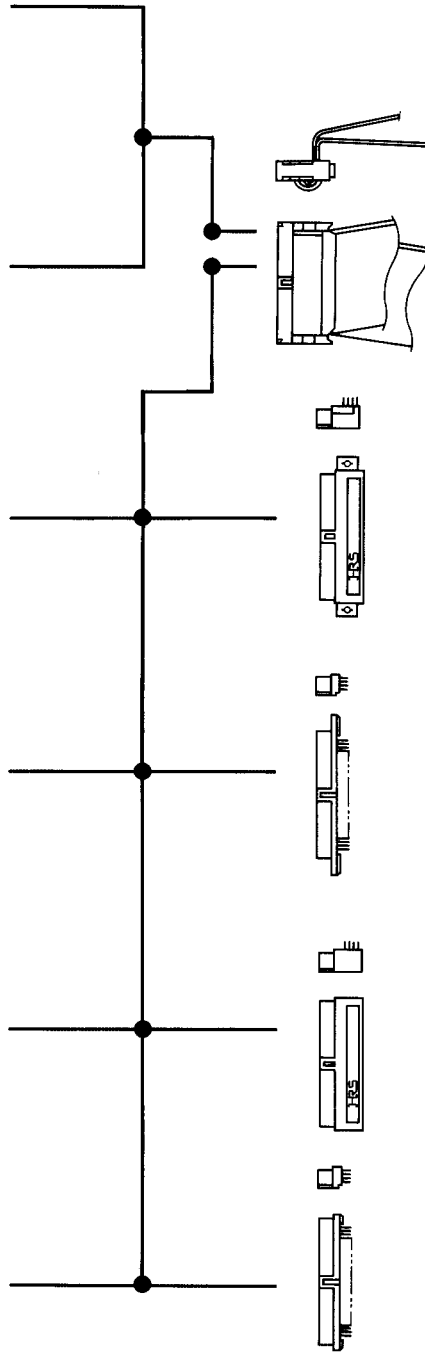
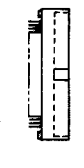

Two pieces of 1.27mm
pitch cable used

➔2.54 pitch connector
(MIL-C-83503)

HIF2B series
HIF3B series
HIF5 series
Ribbon cable FD
(D sub) connector
Ribbon cable RC30
(Micro ribbon) connector

Right Angle
Type with
mounting hole

Straight Type
with mounting
hole

Right Angle
Type without
mounting hole

Straight Type
without
mounting hole

Pin Header Straight Type Without Mounting hole

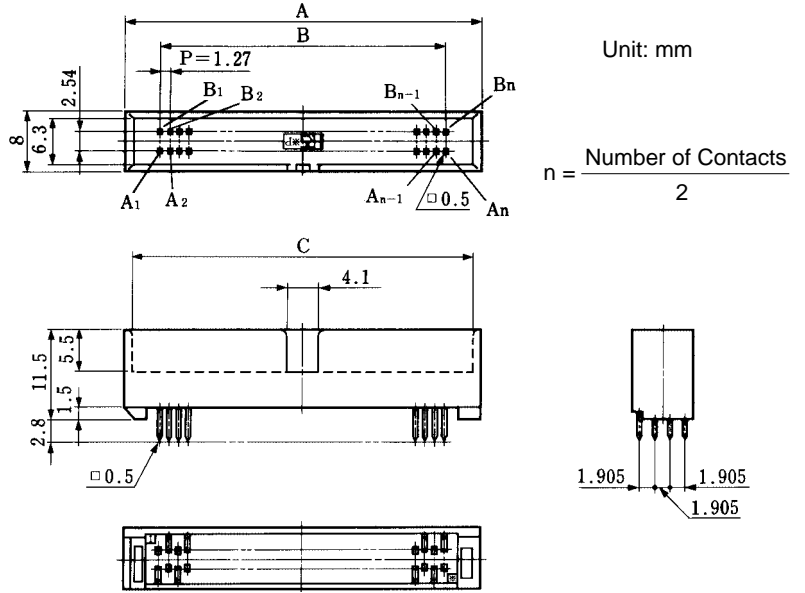
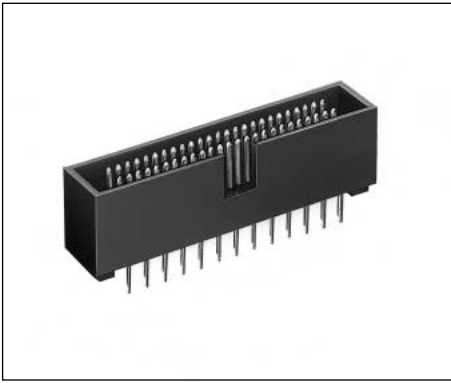

PCB mounting pattern

Guide Key Side

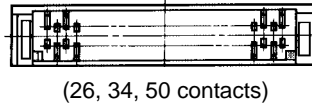
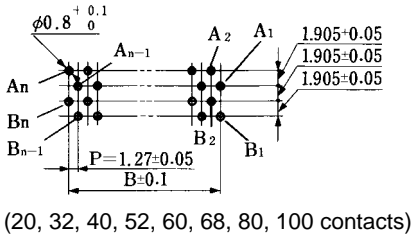

Application Pattern

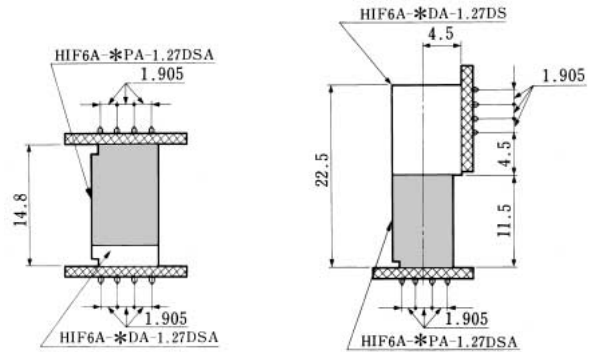

Guide Key Side

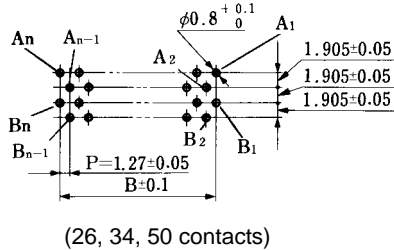

Unit: mm

Part Number	CL No.	Number of Contacts	A	B	C
HIF6A- 20PA-1.27DSA	631-0301-4	20	20.95	11.43	18.75
HIF6A- 26PA-1.27DSA	631-0302-7	26	24.76	15.24	22.56
HIF6A- 32PA-1.27DSA	631-0303-0	32	28.57	19.05	26.37
HIF6A- 34PA-1.27DSA	631-0304-2	34	29.84	20.32	27.64
HIF6A- 40PA-1.27DSA	631-0305-5	40	33.65	24.13	31.45
HIF6A- 50PA-1.27DSA	631-0306-8	50	40.00	30.48	37.80
HIF6A- 52PA-1.27DSA	631-0307-0	52	41.27	31.75	39.07
HIF6A- 60PA-1.27DSA	631-0308-3	60	46.35	36.83	44.15
HIF6A- 68PA-1.27DSA	631-0309-6	68	51.43	41.91	49.23
HIF6A- 80PA-1.27DSA	631-0310-5	80	59.05	49.53	56.85
HIF6A-100PA-1.27DSA	631-0311-8	100	71.75	62.23	69.55

■HIF6 Series: Connection Type Coupled Connector

HIF3B Series (MIL-C-83503)

- Compliant with the MIL standard
- The VA idea is reflected on both pin header and socket.
- Products with pull-out tab are available.
- Countermeasures are taken against noises in combination with the applicable cover case.
- The type aligned in single-row, low profile type, is available for pin header locking system, in addition to standard products.

Number of contacts: 6, 10, 14, 16, 20, 26, 30, 34, 40, 50, 60, 64

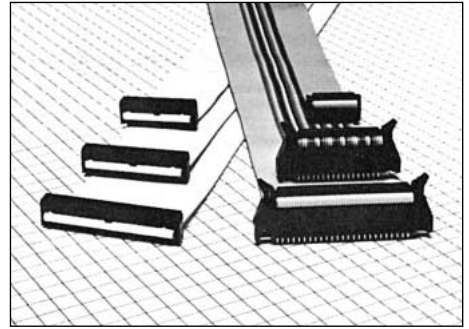

HIF2 Series (Board direct mount type)

①2-row parallel type (HIF2E)

Number of contacts: 10, 14, 16, 20, 26, 30, 34, 40, 50, 60
2.54mm grid alignment facilitates to the design pattern.

②4-row staggered type (HIF2C)

Number of contacts: 10, 14, 16, 20, 26, 30, 34, 40, 50, 60
Mounting height is 4.9mm low profile type.

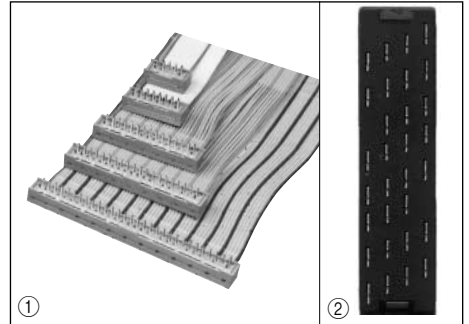

HIF5 Series (Card edge ribbon type)

- Three types of full hole, semi-hole and no mount area are provided for the unit mount area.
- Connectors are connected in the bus line system.
- Cables can be returned within the connector mold width.

Number of contacts: 20, 26, 34, 40, 50, 60

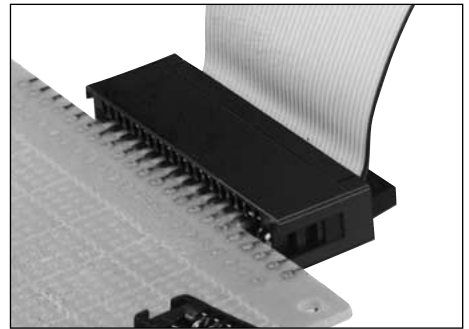

RC Series (Micro ribbon connector)

- Since the cable insulation displacement area is standard pitch 1.27mm, the standard ribbon cable can be easily utilized.
- Countermeasures are taken against noises in combination with the cover case.
- Cover case is light weight and compact.
- Straight and right angle types are installed on the dip side.

Number of contacts: 14, 24, 36, 50

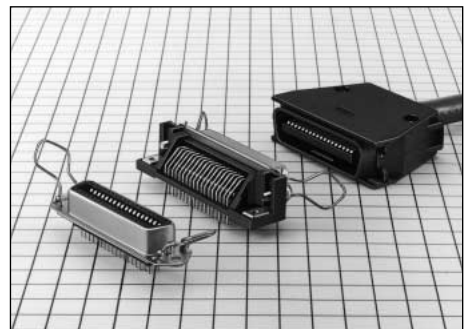

FD Series (D sub-ribbon connector)

- The standard pitch 1.27mm ribbon cable can be insulated and displaced by replacing a jig, in addition to the same pitch 1.38mm as for the D sub connector.
- The space saving type allows to reduce the thickness on the connection side according to set miniaturization.
- Connectors can be installed from both front and rear sides of the chassis or panel.

Number of contacts: 9, 15, 25, 37

